

NI3-EG08-AP6X-H1341

Inductive Sensor

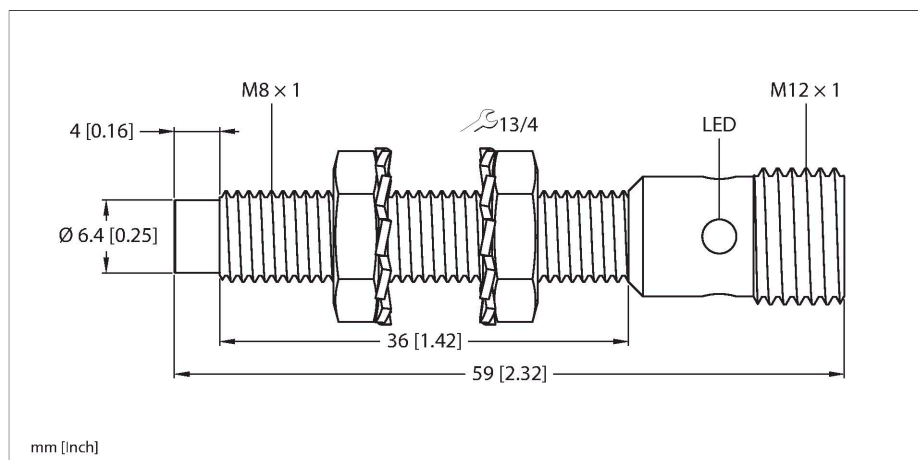

Features

- M8 × 1 threaded barrel
- Stainless steel, 1.4305 (AISI 303)
- DC 3-wire, 10...30 VDC
- NO contact, PNP output
- M12 x 1 male connector

Wiring diagram

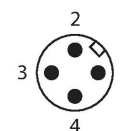
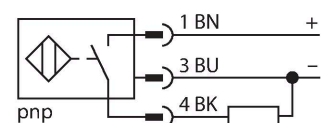

Technical data

Type	NI3-EG08-AP6X-H1341
ID	4602760
General data	
Rated switching distance	3 mm
Mounting conditions	Non-flush
Secured operating distance	≤ (0.81 × Sn) mm
Correction factors	St37 = 1; Al = 0.3; stainless steel = 0.7; Ms = 0.4
Repeat accuracy	≤ 2 % of full scale
Temperature drift	≤ ±10 %
Hysteresis	20 %
Electrical data	
Operating voltage	10...30 VDC
Residual ripple	≤ 10 % U _{ss}
DC rated operational current	≤ 150 mA
No-load current	15 mA
Residual current	≤ 0.1 mA
Isolation test voltage	≤ 0.5 kV
Short-circuit protection	yes / Cyclic
Voltage drop at I _o	≤ 1.8 V
Wire breakage/Reverse polarity protection	yes / Complete
Output function	3-wire, NO contact, PNP
Switching frequency	3 kHz
Mechanical data	
Design	Threaded barrel, M8 x 1
Dimensions	59 mm
Housing material	Stainless steel, 1.4305 (AISI 303)

Functional principle

Inductive sensors detect metal objects contactless and wear-free. For this, they use a high-frequency electromagnetic AC field that interacts with the target. Inductive sensors generate this field via an RLC circuit with a ferrite coil.

Technical data

Active area material	Plastic, PBT
Max. tightening torque of housing nut	5 Nm
Electrical connection	Connector, M12 × 1
Environmental conditions	
Ambient temperature	-25...+70 °C
Vibration resistance	55 Hz (1 mm)
Shock resistance	30 g (11 ms)
Protection class	IP67
MTTF	2283 years acc. to SN 29500 (Ed. 99) 40 °C
Switching state	LED, Yellow

Mounting instructions

Mounting instructions/Description



Distance D	3 x B
Distance W	3 x Sn
Distance T	3 x B
Distance S	1.5 x B
Distance G	6 x Sn
Distance N	2 x Sn
Diameter active area B	Ø 8 mm

Accessories

BST-08B

6947210

Mounting clamp for threaded barrel sensors, with dead-stop; material: PA6

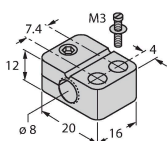

MW-08

6945008

Mounting bracket for threaded barrel sensors; material: Stainless steel A2 1.4301 (AISI 304)

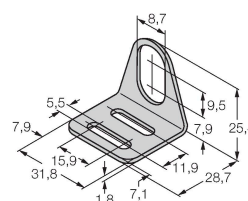

BSS-08

6901322

Mounting clamp for smooth and threaded barrel sensors; material: Polypropylene

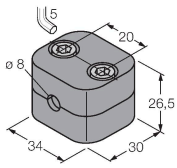

MBS80

69479

Mounting clamp for smooth barrel sensors; mounting block material: Anodized aluminum

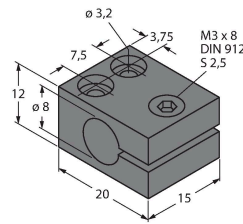

Accessories

Dimension drawing	Type	ID	
	RKH4-2/TFE	6935482	Connection cable, M12 female connector, straight, 3-pin, stainless steel coupling nut, cable length: 2 m, jacket material: PVC, gray; temperature range: -25...+80 °C
	RKH4-2/TFG	6934384	Connection cable, M12 female connector, straight, 3-pin, stainless steel coupling nut, cable length: 2 m, jacket material: TPE, gray; temperature range: -40...+105 °C